

# ACCESSORIES

## Fisher® Padded Carry Bag

Rugged double stitched construction. Includes handy exterior pocket for extra batteries or small accessories. – 103693000C

## Fisher® Camo Pouch

Camo pouch with two inside pockets, belt included. – PCH-F

## Stereo Headphones

Use with Fisher® metal detectors. Lightweight and adjustable with true stereo sound, adjustable volume, 1/4 jack with 1/8 adaptor, 4' cable. – 9720950000

## Metal Sand Scoop

Large galvanized metal scoop with filtering holes. Strong Rubberized grip. – SAND SCOOP

## Lesche Knife

Made from high quality heat-treated tempered steel. The ultimate digging tool. Comes with a durable sheath. 12" in length with a 7" serrated blade. – LESCHE KNIFE

## Fisher® Baseball Cap

One size fits all. – FCAP

## Fisher® T-Shirt

100% cotton with Fisher® Logo. Sizes: S, M, LG, XL & XXL – FTSHIRT

## Replacement/Accessory Searchcoils

7" Round Elliptical Replacement Coil – 7COIL-RE-F

9" Triangulated Concentric Elliptical Accessory Coil – 9COIL-EE

11" Triangulated Concentric Elliptical Accessory Coil – 11COIL-EE

## Coil Covers

Specially made to protect your searchcoil from abrasion and damage.

9" Triangulated Concentric Elliptical Coil Cover– 9COVER-EE

11" Triangulated Concentric Elliptical Coil Cover– 11COVER-EE

## Rain Cover

Neoprene protective cover specially made to protect your F11 from weather– COV-F11

## Gold Prospecting Kits

### Items Included:

|                        | Gold Kit<br>PART NUMBER:<br>GOLDKIT1 | Deluxe Kit<br>PART NUMBER:<br>GOLDKIT2 | Hardrock Kit<br>PART NUMBER:<br>GOLDKIT3 |
|------------------------|--------------------------------------|--|--|
| 10 1/2" Gold Pan       | x                                    | x                                      | x  |
| 14" Gold Pan           | x                                    | x                                      | x  |
| Classifier             |                                      | x                                      | x  |
| 2 – Shatterproof Vials | x                                    | x                                      | x  |
| Snuffer Bottle         | x                                    | x                                      | x  |
| Black Sand Magnet      |                                      | x                                      | x  |
| Treasure Scoop         |                                      | x                                      | x  |
| Tweezers               |                                      |  | x  |
| Magnifier              |                                      |  | x  |
| Crevice Tool           |                                      |  | x  |
| Rock Pick              |                                      |  | x  |
| Instruction Booklet    | x                                    | x                                      | x  |
| Backpack               |                                      | x                                      | x  |

FOR COMPLETE DETAILS VISIT [WWW.FISHERLAB.COM](http://WWW.FISHERLAB.COM) • 1-800-685-5050

**FISHER** RESEARCH LABS



## OWNER'S MANUAL

Uses one 9-volt **ALKALINE** battery only. Do not use "Heavy Duty" batteries. Do not use ordinary Zinc Carbon batteries.



## Congratulations!

Congratulations on the purchase of your new Fisher F11™ Metal Detector. The F11 is the result of many years of software engineering and features the latest advancements in lightweight design and target accuracy. The F11 can be used with its default turn-on-and-go settings, or you can adjust the detector's settings to match your hunting conditions. This detector was designed to be an easy to use yet powerful detector. This manual has been written to help you get optimal use of your detector so we hope you will read it thoroughly before your first outing.

*Happy Hunting from Fisher Research Labs!*

**The F11 operates at a frequency of 7.69 kHz and comes with a 7" round elliptical searchcoil. The F11 shares searchcoil compatibility with the F22 and F44.**

## TABLE OF CONTENTS

|  |           |
|--|-----------|
| Terminology . . . . .                        | 3         |
| Contents of Box . . . . .                    | 4         |
| Assembly . . . . .                           | 5-6       |
| Batteries (use alkaline batteries) . . . . . | 7         |
| Quick-Start Demonstration . . . . .          | 8         |
| The Basics of Metal Detecting                |           |
| Ground Minerals . . . . .                    | 9         |
| Trash . . . . .                              | 9         |
| Identifying Buried Objects . . . . .         | 9         |
| Depth of Buried Objects . . . . .            | 10        |
| EMI (Electromagnetic Interference) . . . . . | 10        |
| Using the Detector . . . . .                 | 10        |
| Waterproof Searchcoil . . . . .              | 10        |
| How to Work the Controls . . . . .           | 11        |
| The Display                                  |           |
| Depth Indicator . . . . .                    | 12        |
| Overload Warning . . . . .                   | 12        |
| Target Identification                        |           |
| Target-ID . . . . .                          | 12        |
| 4-Tone Target Identification Bar . . . . .   | 12-13     |
| Depth and Target Display                     |           |
| Reading the Display . . . . .                | 13        |
| Target Group Category ID . . . . .           | 14        |
| Controls                                     |           |
| Volume . . . . .                             | 14        |
| Sensitivity . . . . .                        | 14        |
| Notch . . . . .                              | 15        |
| Pinpoint . . . . .                           | 15        |
| Pinpointing . . . . .                        | 15-16     |
| Headphone Jack . . . . .                     | 16        |
| Characteristics & Limitations . . . . .      | 17        |
| Troubleshooting . . . . .                    | 18        |
| Treasure Hunter's Code of Ethics . . . . .   | 19        |
| Warranty . . . . .                           | 19        |
| Accessories . . . . .                        | Back Page |

## TREASURE HUNTER'S CODE OF ETHICS:

- Always check Federal, State, County and local laws before searching.
- Respect private property and do not enter private property without the owner's permission.
- Take care to refill all holes and leave no damage.
- Remove and dispose of any and all trash and litter found.
- Appreciate and protect our inheritance of natural resources, wildlife and private property.
- Act as an ambassador for all treasure hunters; use thoughtfulness, consideration and courtesy at all times.
- Never destroy historical or archaeological treasures.
- All treasure hunters may be judged by the example you set; always conduct yourself with courtesy and consideration of others.

## 5-YEAR LIMITED WARRANTY

Register your warranty on-line for a chance to win a

**FREE DETECTOR**

For details, visit [www.fisherlab.com](http://www.fisherlab.com)

The **F11** metal detector is warranted against defects in materials and workmanship under normal use for five years from the date of purchase to the original owner.

Damage due to neglect, accidental damage or misuse of this product is not covered under this warranty. Decisions regarding abuse or misuse of the **F11** metal detector are made solely at the discretion of the manufacturer.

**Proof of Purchase is required to make a claim under this warranty.**

Liability under this Warranty is limited to replacing or repairing, at our option, the metal detector returned, shipping cost prepaid, to Fisher Research Labs. Shipping cost to Fisher Research Labs is the responsibility of the consumer.

To return your detector for service, please first contact Fisher Research Labs for a Return Authorization (RA) Number. Reference the RA number on your package and return the detector within 15 days of calling to:

### Fisher Research Labs

1465 Henry Brennan Dr.

El Paso, TX 79936

Phone: 915-225-0333 ext. 118

### NOTICE TO CUSTOMERS OUTSIDE THE U.S.A.

This warranty may vary in other countries; check with your distributor for details. Warranty does not cover shipping costs to and from the U.S.A.

According to FCC part 15.21, changes or modifications made to this device not expressly approved by the party responsible for compliance could void the user's authority to operate this equipment. This device complies with FCC Part 15 Subpart B Section 15.109 Class B.

Copyright © 2015

All rights reserved, including the right to reproduce this book, or parts thereof, in any form. Fisher® is a registered trademark of Fisher Research Labs

[www.fisherlab.com](http://www.fisherlab.com)

Made in the USA from USA and imported parts.

**FISHER** RESEARCH LABS



| <b>TROUBLESHOOTING GUIDE</b>   |   |  |
|--|---|--|
| <b>SYMPTOM</b>   | <b>CAUSE</b>  | <b>SOLUTION</b>  |
| Detector chatters, beeps erratically or has low sensitivity                | <ul style="list-style-type: none"> <li>Using detector indoors</li> <li>Using detector near power lines</li> <li>Using 2 detectors in close proximity</li> <li>Environmental electromagnetic interference</li> </ul> | <ul style="list-style-type: none"> <li>Use detector outdoors only</li> <li>Move away from power lines</li> <li>Keep 2 detectors at least 6 meters (20') apart</li> <li>Reduce sensitivity until erratic signals cease</li> </ul> |
| Low speaker volume   | <ul style="list-style-type: none"> <li>Discharged battery</li> <li>Wrong type of battery</li> </ul>   | <ul style="list-style-type: none"> <li>Replace battery</li> <li>Use only 9Volt <b>alkaline</b> battery</li> </ul>  |
| Display does not lock on to one Target-ID or detector emits multiple tones | <ul style="list-style-type: none"> <li>Multiple targets present</li> <li>Highly mineralized soil</li> <li>Sensitivity set too high</li> </ul>   | <ul style="list-style-type: none"> <li>Sweep searchcoil at different angles</li> <li>Move to a different location</li> <li>Reduce sensitivity</li> </ul>   |
| No power, no sounds  | <ul style="list-style-type: none"> <li>Dead battery</li> <li>Cable not connected securely</li> </ul>  | <ul style="list-style-type: none"> <li>Replace battery</li> <li>Check connections</li> </ul>   |

**Note:** This equipment has been tested and found to comply with the limits for a Class B digital device, pursuant to part 15 of the FCC Rules. These limits are designed to provide reasonable protection against harmful interference in a residential installation. This equipment generates, uses and can radiate radio frequency energy and, if not installed and used in accordance with the instructions, may cause harmful interference to radio communications. However, there is no guarantee that interference will not occur in a particular installation. If this equipment does cause harmful interference to radio or television reception, which can be determined by turning the equipment off and on, the user is encouraged to try to correct the interference by one or more of the following measures:

- Reorient or relocate the receiving antenna.
- Increase the separation between the equipment and receiver.
- Consult the dealer or an experienced radio/TV technician for help.

CE The manufacturer declares that the minimum ESD performance criteria is 1) the unit shall not be permanently damaged and 2) operator intervention is allowed.

This product is RoHS compliant.

This product meets the requirements of Industry Canada: CAN ICES-3 B/NMB-3 B.

## **TERMINOLOGY**

The following terms are used throughout the manual and are standard terminology among detectorists.

### **RELIC**

A relic is an object of interest by reason of its age or its association with the past. Many relics are made of iron, but can also be made of bronze or precious metals.

### **IRON**

Iron is a common, low-grade metal that is an undesirable target in certain metal detecting applications. Examples of undesirable iron objects are old cans, pipes, bolts and nails. Sometimes the desired target is made of iron. Property markers, for instance, contain iron. Valuable relics can also be composed of iron; cannon balls, old armaments and parts of old structures and vehicles can also be composed of iron.

### **FERROUS**

Metals which are made of, or contain iron.

### **ELIMINATION**

Reference to a metal being "eliminated" means the detector will not emit a tone, nor display a Target-ID, when a metal object passes through the searchcoil's detection field.

### **DISCRIMINATION**

When the detector emits different tones for different types of metals, and when the detector "eliminates" certain metals, we refer to this as the detector "discriminating" among different types of metals.

Discrimination is an important feature of professional metal detectors. Discrimination allows the user to ignore trash and otherwise undesirable objects.

### **PINPOINTING**

Pinpointing is the process of finding the exact location of a buried object. Long-buried metals can appear exactly like the surrounding soil and can therefore be very hard to isolate from the soil.

### **GROUND CANCELATION**

Ground Cancellation is the ability of the detector to ignore, or "see through," the earth's naturally occurring minerals, and only sound a tone when a metal object is detected. This detector incorporates proprietary circuitry to eliminate false signals from many mineralized soils.

## CONTENTS OF BOX

The following detector components are in the box:

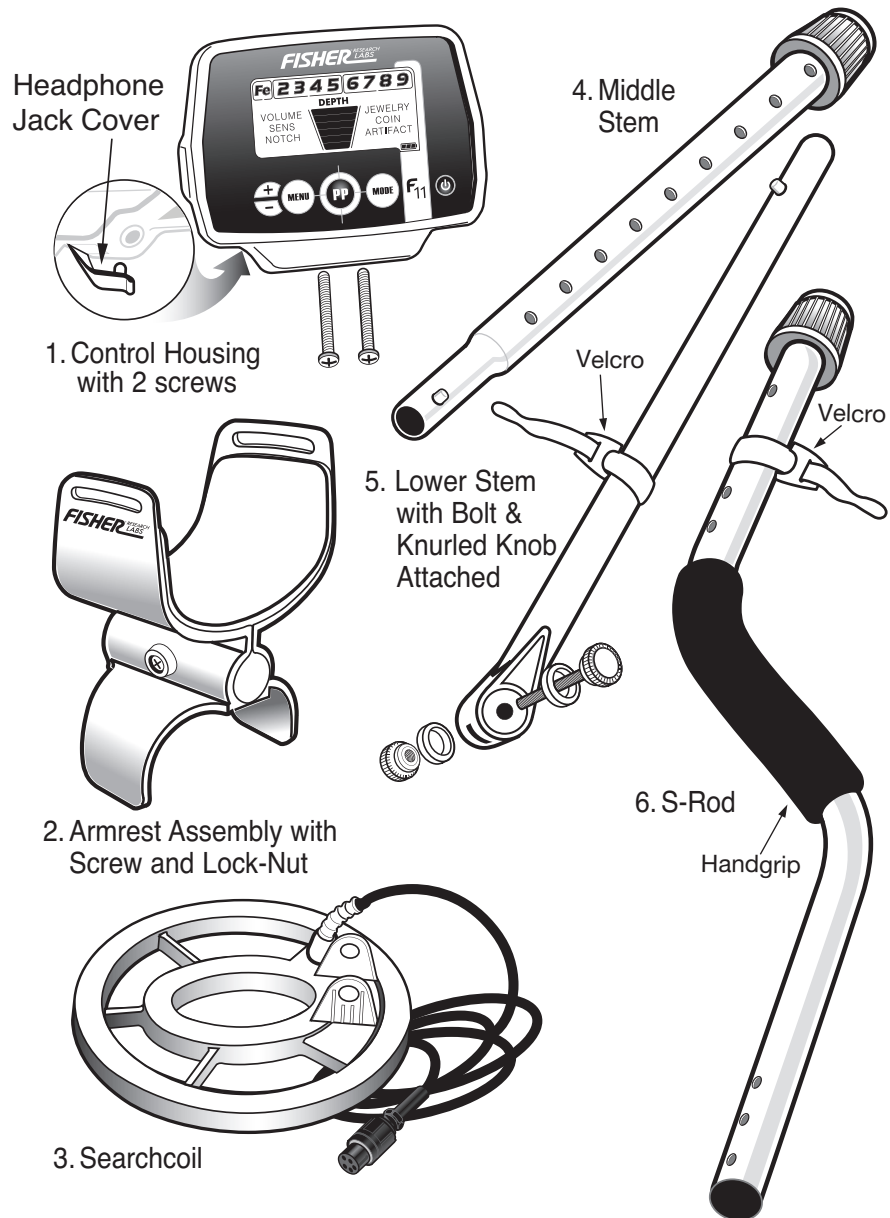

## CHARACTERISTICS & LIMITATIONS

1. This detector comes with a waterproof searchcoil. The searchcoil can be completely submerged into water. The control housing is not waterproof and cannot be submerged in water. To use the detector in inclement weather, consider purchasing the optional Rain Cover (COV-F11).
2. BURIED UTILITY LINES. This hobby metal detector is not designed to locate buried pipes or cables. Fisher Research Labs manufactures a complete line of pipe and cable locators for this application. These are sophisticated instruments with functionality different from your hobby metal detector.
3. SEVERE SOIL CONDITIONS. While this detector has proprietary circuitry to cancel out minerals naturally occurring in most soil types, it cannot penetrate the most severe soils and it is not intended for use on wet sand saltwater beaches. However, it is well-suited for detecting on dry sand. Saltwater is highly conductive and requires a more sophisticated type of detector. Fisher Research Labs offers such types of detectors. Other highly mineralized soils, such as those found in some gold prospecting sites, may also limit this detector's capability. If the detector tends to overload it could indicate you are in an area containing such severe soils.
4. TARGET-ID. The detector's Target-ID system calculates and displays the most probably identification. Target-ID is affected by soil conditions, the searchcoil's distance from the target, the length of time the target has been buried and the target's proximity to other dissimilar targets. Very large metal objects can overload the detector and may be classified inaccurately.
5. REDUCE SENSITIVITY. The primary purpose of the Sensitivity control is to allow the operator to reduce the sensitivity of the detector. All detectorists desire to find objects at maximum depth. However, in today's environment there is a never-ending variety of devices emitting EMI (Electromagnetic Interference) that can interfere with this detector.

There will be environments where the detector cannot operate at maximum sensitivity. This is not a defect. If you find yourself in such an environment, reduce the sensitivity of the detector. Some environments may have so much EMI it is impossible to detect there. Both overhead power lines and buried power lines can interfere with this detector. Power line capacity may be quite different during certain times of the day. For instance, peak hours of electrical use that can occur around 6 p.m. can lead to a lot of EMI. If you experience power line interference, try returning to a given area at a different time of day.



## PINPOINTING *(Continued)*

### CIRCLING THE TARGET

Crossing the target zone with multiple intersecting sweeps at multiple angles is another way to verify the repeatability of the signal and the potential of the buried target. To use this method, walk around the target area in a circle, sweeping the searchcoil across the target repeatedly every 30 to 40 degrees of the circle, about ten different angles as you walk completely around the target. If a high-tone target completely disappears from detection at a given angle, chances are you are detecting oxidized ferrous metals, rather than a silver or copper object. If the tone changes at different angles, you may have encountered multiple objects. If you are new to the hobby, you may want to dig all targets at first. With practice in the field, you will learn to better discern the nature of buried objects by the nature of the detector's response.

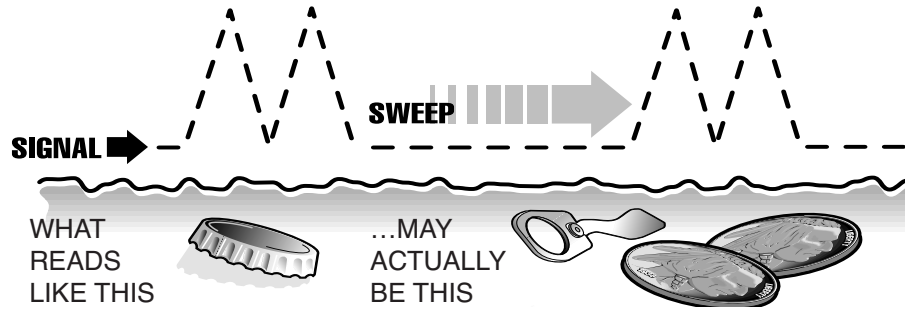

## HEADPHONE JACK

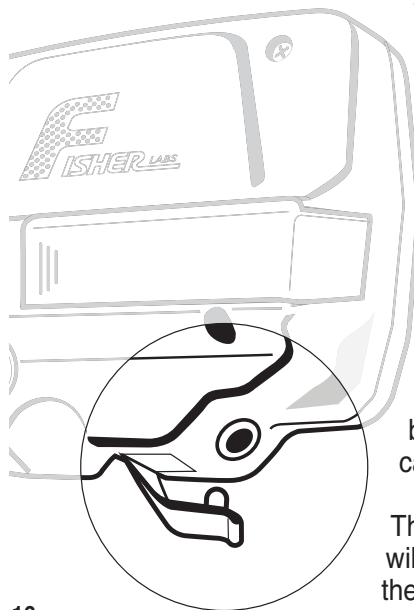

This detector has a 1/4" headphone jack. It works with any stereo headphone (not included) that has a 1/4" plug. When the headphone jack is connected, speaker volume is disabled. Using headphones extends battery life and prevents the sounds from bothering bystanders. Headphone use also facilitates detection of the weakest signals.

For safety reasons, do not use headphones near traffic or where other dangers are present. This device is not to be used with interconnecting or headphone cables longer than three meters.

The headphone jack has a rubber plug that will help keep foreign material from entering the control box.

## ASSEMBLY

### Tool Required: #1 Phillips Screwdriver

- 1 • Remove the Screw from the Armrest.
  - Slide the Armrest over the end of the S-Rod.
  - Attach with Screw and Lock-Nut.

- 2 Attach Control Housing with Screws; install back screw first.

### NOTE:

- The Handgrip fits under the Control Housing. Handgrip may partially cover one mounting hole. Peel back Handgrip to expose the front hole.
- Ensure the headphone jack cover is properly seated before attaching the control housing.

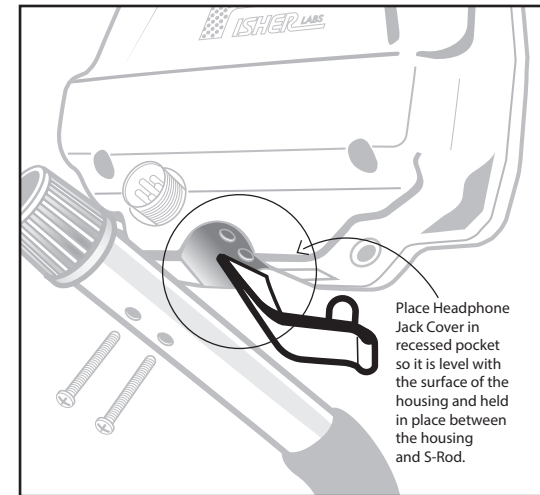
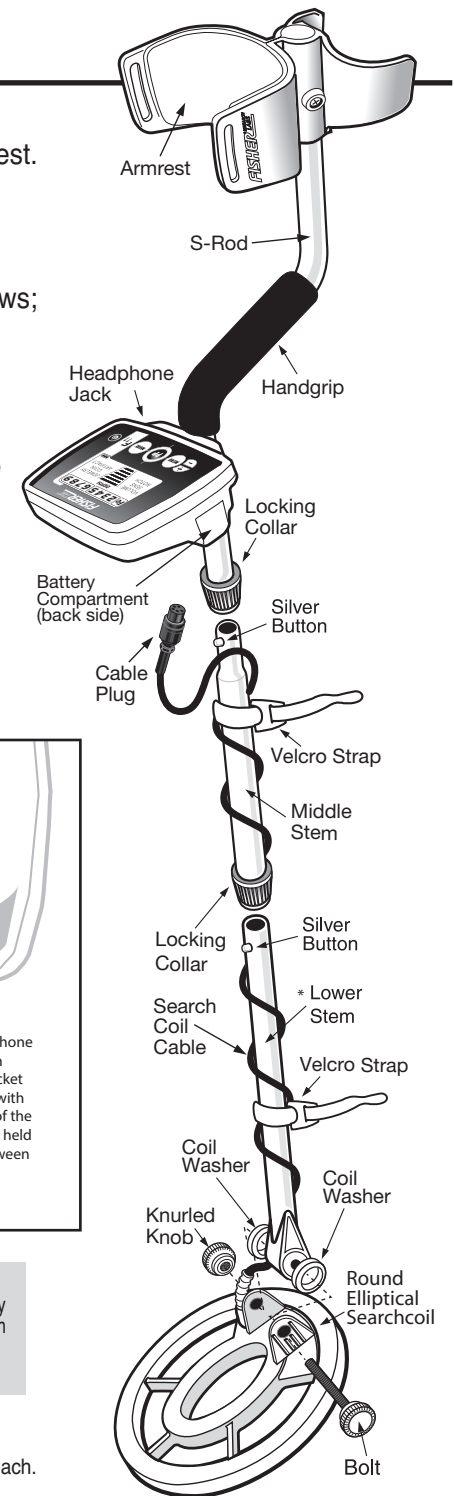

**Caution:**  
Forcing in MIDDLE STEM with CAM LOCK raised may form a burr on cam lock. If this happens, remove burr with knife to allow insertion.

\* Note: Very tall users can purchase the optional Extended Lower Stem (TUBE5X), for extended reach.

## ASSEMBLY (Continued)

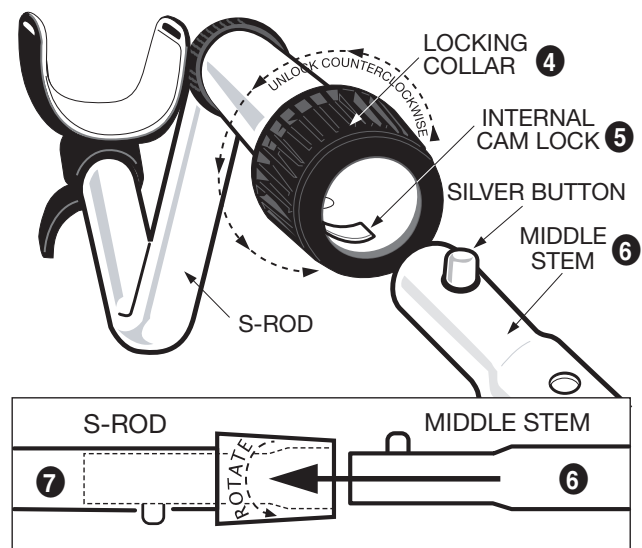

- 3 Position S-Rod upright.
- 4 Rotate the LOCKING COLLAR fully in the counterclockwise direction.
- 5 Insert your finger inside the tube and make sure the INTERNAL CAM LOCK is flush with the inside of the tube.
- 6 Insert the MIDDLE STEM into the S-ROD, with the SILVER BUTTON pointed upward.
- 7 Rotate the MIDDLE STEM until the SILVER BUTTON locates in the hole.
- 8 Twist the LOCKING COLLAR fully in the clockwise direction until it locks.
- 9 Repeat this process on the LOWER STEM.
- 10 Using the BOLT and KNURLED KNOB, attach the SEARCHCOIL to the LOWER STEM.
- 11 Adjust the LOWER STEM to a length that lets you maintain a comfortable upright posture with your arm relaxed at your side, and the SEARCHCOIL parallel to the ground in front of you.
- 12 Wind the CABLE securely around the STEMS, leaving slack at the bottom.
- 13 Connect CABLE PLUG to housing.  
Do not twist the Cable or Plug. Turn Locking Ring only. Use minimal finger pressure to start the threads. Do not cross-thread. When the Locking Ring is fully engaged over the threaded connector, give it a firm turn to make sure it is very tight. When the Locking Ring is fully engaged over the threaded connector, it may not cover all of the threads.

6

## CONTROLS (Continued)

That category will reverse status. If the icon had previously been illuminated it will now disappear, indicating the category has been eliminated from detection. Likewise, an icon that is not visible on the display will re-illuminate, indicating that this category is now notched-in and will be detected.

Only one category can be notched at a time. To notch multiple categories in or out, repeat the process for each category icon.

### PINPOINT

Press and hold the  button to activate. Pinpoint is only active while the button is depressed. The 2-digit indicator displays the target depth in inches and updates immediately as the coil moves back and forth over the target. The depth indication in conjunction with the variable pitch and volume help pinpoint the exact center of a target.

Pinpoint is used to find the exact location of a target which was previously located and identified using the Jewelry, Coin or Artifact mode. Pinpoint does not require motion of the searchcoil over the target; the user can move the searchcoil more slowly and narrow the detection field.

### NARROW IT DOWN

To further narrow the field of detection, position the searchcoil near the center of the response pattern (but not at the exact center), release, and then quickly press-and-hold it again. Now you will only hear a response when the searchcoil is right over the top of the target. Repeat this procedure to narrow the zone even further. Each time you repeat the procedure, the field of detection will narrow further.

## PINPOINTING (using a motion detecting mode)

### Pinpointing targets after detection

#### "X-ing" the target

1. Sweep over target in narrowing side-to-side patterns.
2. Take note of the spot on the ground where the "beep" occurs.
3. Now sweep over the target in a forward-to-back motion and note where the "beep" occurs.
4. This pinpoints the target location with "X".

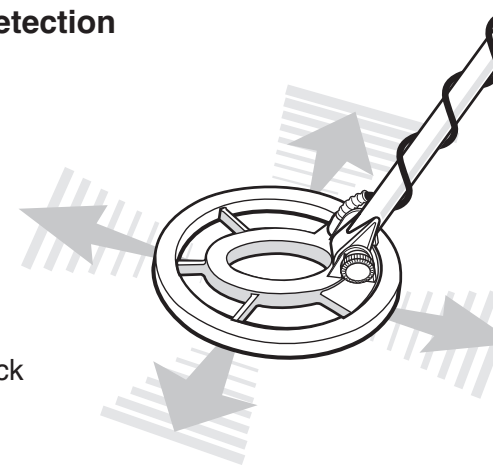

When pinpointing a target, try drawing an "X", as illustrated, over where the tone is induced.

15

## DEPTH AND TARGET DISPLAY (Continued)

The scale for coin-sized objects, with sensitivity at maximum, is:

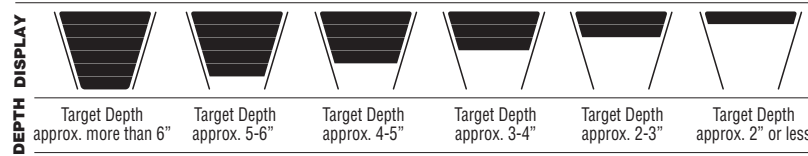

### Target-ID Coin Reference *Below are known Target-IDs for some reference coins:*

|   |   |   |     |
|---|---|---|-----|
| Merovingian Triens (gold, France)             | 2 | 1 Euro Coin   | 4-5 |
| Celtic Potin (copper+lead)                    | 2 | Medieval double sol coin (France)                   | 5   |
| Russian Scale Peter I, 1705, Silver, 0.25 gr. | 3 | British £1  | 5-6 |
| US Nickel                                     | 3 | US Dime   | 6   |
| Roman Nummus (bronze)                         | 4 | Polish Zloty (Pre-WWII) 2zl (1933 silver)           | 7   |
| 2 Euro Coin                                   | 4 | US Quarter  | 7   |
| British 20p                                   | 4 | US Silver Dollar                                    | 9   |
| USSR, 5 kopeek, 1961, Bronze, D 25 mm.        | 4 | Russian, 1 ruble Nikolay II, 1896, Silver, D 34 mm. | 9   |
| Bulgarian 1 lev                               | 4 |   |     |

## CONTROLS

### VOLUME

Adjust the volume from 0 to 6. At startup the default level is 4. Press the Menu button until "Volume" is illuminated, then use the "+" and "-" buttons to adjust up or down.

Minimum volume is 0 bars  
Maximum volume is 6 bars

### SENS (Sensitivity)

Adjust the sensitivity from 1 to 6. At startup the default level is 5.

Minimum sensitivity is 1 bar  
Maximum sensitivity is 6 bars

If the detector beeps erratically or beeps when there are no metal objects being detected, **reduce the sensitivity.**

Press the Menu button until SENS is displayed, then use the "+" and "-" buttons to adjust up or down.

**WARNING: Reduce the sensitivity** if the detector behaves erratically.

*In today's wireless & technological environment there is a never-ending*

*variety of devices emitting EMI (Electromagnetic Interference) that can interfere with this detector.*

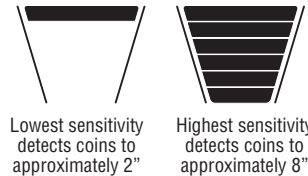

### NOTCH

The Notch control allows you to accept or reject different types of metals for each target category group. All categories are eligible for NOTCH. Each mode (Jewelry, Coin and Artifact) has a default set of notches.

Press the Menu button until Notch is illuminated. With each press of the "+" or "-", the blinking Target Category icon moves across the display screen. Position the blinking icon on the category you wish to notch and wait 5 seconds or press the **MENU** button for immediate notch selection.

## BATTERIES

The detector requires a single 9-volt ALKALINE battery (included).

**Do not use ordinary "Zinc Carbon" batteries.**

**Do not use "Heavy Duty" batteries.**

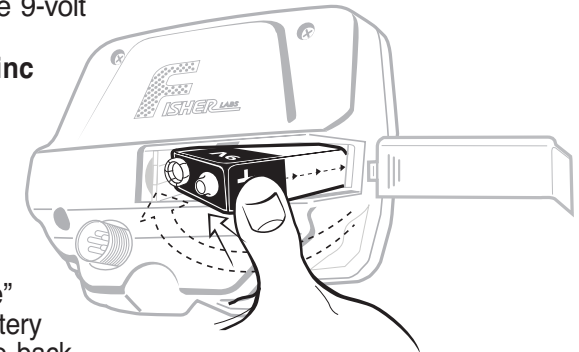

Rechargeable batteries can also be used. If you use rechargeable, we recommend using a "Nickel Metal Hydride" rechargeable battery. The battery compartment is located on the back side of the Control Housing. Slide the battery door to the side to remove. Insert battery (see illustration). Close battery door. When it is time to replace the battery, simply pull up firmly on the end of the battery.

### BATTERY LIFE

Expect 20 to 25 hours of life from a 9-volt alkaline battery. Rechargeable batteries provide about 8 hours of usage per charge.

### BATTERY INDICATOR

The battery icon has three segments plus an outline segment.

The amount of battery voltage for an ALKALINE battery is indicated as follows:

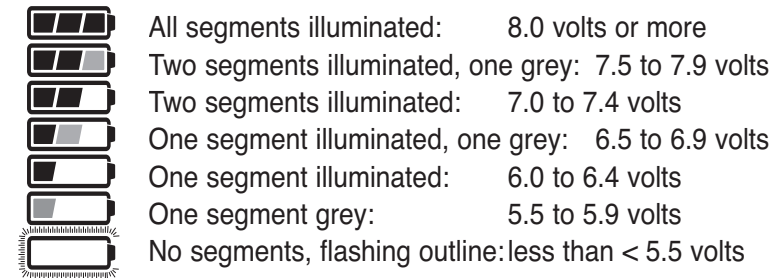

It is recommended to change the batteries when you see one grey segment. If using NiMH rechargeable batteries, the display will remain stuck on the second or third bar for most of the battery life; when it drops to the first bar, the batteries will go dead within minutes.

### SPEAKER VOLUME AND BATTERY CHARGE

You may notice the speaker volume drop while one battery segment is illuminated. With the outline flashing, low speaker volume will be very apparent.

### BATTERY DISPOSAL & RECYCLING

Alkaline batteries may be disposed of in a normal waste receptacle or recycled. Non-Alkaline batteries should be recycled. In the state of California all battery types must be recycled. Please refer to local municipalities for detailed disposal and recycling requirements.





# QUICK-START DEMONSTRATION

## I. Supplies Needed

- Nail (made of iron) • U.S. Quarter (or silver coin) • U.S. Nickel
- Gold Ring • U.S. Dime • U.S. Penny, dated after 1982 (post-1982 pennies are made of Zinc)  
(Most newer non-U.S. coinage also contains mostly Zinc)

## II. Position the Detector



- a. Place the detector on a table with the searchcoil hanging over the edge. (or, have a friend hold the detector with the searchcoil off the ground).
- b. Keep the searchcoil away from walls, floors and metal objects.
- c. Remove watches, rings and jewelry.
- d. Turn off lights or appliances whose electromagnetic emissions may cause interference.
- e. Pivot the searchcoil back.
- f. Press  to power on.
- g. Press  twice to enter Artifact Mode, notice all target groups illuminated.



## III. Demonstrate MODES:

- a. Pass all objects over the searchcoil and notice the different tones.
  - Nail:** low tone
  - Nickel:** medium tone
  - Zinc Penny:** medium tone
  - Gold Ring:** most gold rings will register with a medium tone
  - Dime:** high tone
  - Quarter:** high tone
- b. Wave objects close, notice depth indicator. Wave objects farther away and notice depth indicator.
- c. Press  once to enter Jewelry Mode. Notice Fe graphic is no longer illuminated.
- d. Wave nail over searchcoil. It will not be detected because it has been “discriminated out.”

## IV. Demonstrate NOTCH Feature:

- a. Press  until “NOTCH” is illuminated.
- b. Press  until Icon “3” is flashing, then wait until icon stops flashing (*approximately 5 seconds*). The icon will be blanked out.
- c. Pass nickel over the searchcoil. It will not be detected. The nickel has been “notched” out.
- d. Press  until Icon “3” is flashing, then wait until icon stops flashing (*approximately 5 seconds*). The icon is now illuminated.
- e. The nickel target group is now “notched” back in.

## V. Demonstrate DEPTH Indicator:

- a. Pass the Nickel close to the searchcoil (about 1” away).
- b. Notice the depth bar graph indicating a shallow target.
- c. Wave the Nickel farther away from the searchcoil and notice additional bar graph segments illuminating, indicating a deeper target.

## VI. Demonstrate PINPOINT feature:

- a. Press and hold .
- b. Hold a coin motionless over the searchcoil.
- c. Lower coin toward searchcoil and then raise coin away from searchcoil.
- d. Notice the sound changes as the coin distance varies.
- e. Notice the depth indicator changes as the coin moves up and down.

# TARGET IDENTIFICATION (Continued)

|                 | Iron | Gold |        |      |     | Silver |      |      |        |
|-----------------|------|------|--------|------|-----|--------|------|------|--------|
|                 | Fe   | 2    | 3      | 4    | 5   | 6      | 7    | 8    | 9      |
|                 | Iron | Foil | Nickel | Alum | Zn  | Dime   | Qtr  | Half | Dollar |
| <b>Jewelry</b>  | Bass | Med  | Med    | Med  | Med | High   | High | High | High   |
| <b>Coin</b>     | Bass | Bass | Med    | Bass | Low | High   | High | High | High   |
| <b>Artifact</b> | Bass | Med  | Med    | Med  | Med | High   | High | High | High   |

The Target Category Icons are outlined in three groups: Iron, Gold and Silver.

The effective electrical conductivity of an object depends on its metallic composition, size, shape and orientation relative to the searchcoil. Since coins are minted to tightly controlled specifications, they can be accurately identified. Identification of pull-tabs and foil is less consistent because these kinds of targets come in wide variety. In general, smaller objects, and objects made from lower conductivity alloys such as iron, bronze, brass, lead, pewter and zinc will read lower on the conductivity scale. Larger objects and objects made from higher conductivity alloys such as silver, copper and aluminum, will tend to read higher. The notable exceptions are gold, which usually reads low because it is rarely found in large pieces, and zinc pennies, which read moderately high because of their size and shape. Although nails and other iron and steel objects will usually give low readings, ring-shaped pieces of iron (for instance steel washers and harness rings) will usually produce medium to high readings. Flat pieces of iron or steel, such as can lids, will occasionally do the same.

# DEPTH AND TARGET DISPLAY

## READING THE DISPLAY

The display shows the PROBABLE identification of the metal detected, as well its PROBABLE depth.

Each time an object is detected, the Depth Bar segments illuminates in addition to the Target-ID Icon.

The Bar Graph is a graphic representation of the distance from the searchcoil to a coin-sized object.

- More bars indicate a deeper object.
- Fewer bars indicate a shallower object.

## TARGET GROUP CATEGORY ID

- Fe**-Iron Objects, Gold Flakes
- 2** -Foil, Small Gold Items
- 3** -US Nickels, Gold, Pull Tabs
- 4** -Brass, Aluminum Screw Caps, Lead, 2 Euro Coin, Pull Tabs
- 5** -US Zinc Cents, 1 Euro Coin
- 6** -Copper Coins, Small Silver Coins (US Dime)
- 7** -Medium Silver Coins (US Quarter)
- 8** -Large Silver Coins (US Half Dollar)
- 9** -Very Large Silver Coins (US Silver Dollar)

**Caution:** Many other types of metal items can fall under any one of these categories. It is impossible to accurately classify ALL buried objects.

See *Target ID Coin Reference Chart (Pg 14)*.



## THE DISPLAY

### DEPTH INDICATOR

Coin-sized objects will be detected up to 8" deep.

The 6-segment graphic indicator is calibrated to coin-sized objects.

Objects other than coins will still register on the 6-segment depth scale, but the depth indication will be relative. For example, all 6 segments illuminated could indicate a coin buried 8" deep, but could also be a very large object several feet deep. Use the Depth Indicator in conjunction with the Target Category Icons to gain more information.

### OVERLOAD WARNING

If a metal object or highly magnetic soil are too close to the searchcoil, the detector will *overload* and begin emitting a rapid, repeating mid-tone warning sound. *Overload* will not harm the detector, but the detector will not function under these conditions. If *overload* occurs, raise the searchcoil to detect the target from a greater distance, or move to a different location.

## TARGET IDENTIFICATION

### Target-ID

This is a motion detector. The searchcoil must be in motion to detect metal. A motionless searchcoil over a metal object will not detect metal. When objects are detected, the detector will emit a sound. A Target Category Icon will illuminate indicating the Target-ID of the last object detected. This detector has fast target response and is able to detect different objects in very close proximity. Therefore, the Target-ID displayed may change rapidly as you sweep the searchcoil.

The Category Icon will remain illuminated for 3 seconds and then disappear. **Note:** There are a wide variety of metals and no target can be identified for certain until unearthed. See table on page 13 for a Target-ID Category coin reference.

### 4-Tone Target Identification

The detector will provide 1 of 4 sounds for any metal object detected: bass, low, medium or high tone. This audio feedback system is useful in conjunction with the visual Category Icon system described above.

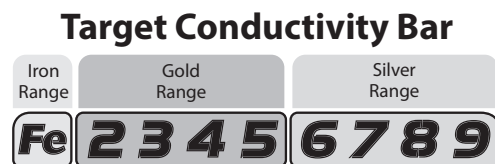
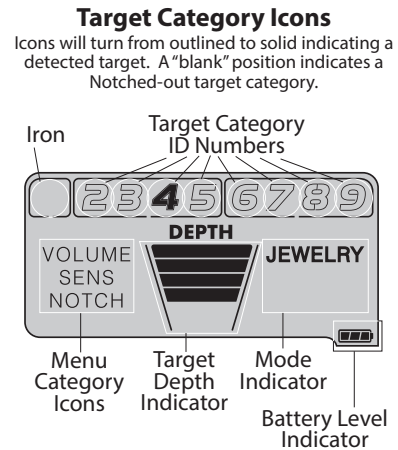

## THE BASICS OF METAL DETECTING

This metal detector is intended for locating buried metal objects. When searching for metals, underground or on the surface, you have the following challenges and objectives:

1. Ignoring signals caused by ground minerals.
2. Ignoring signals caused by metal objects that you do not want to find, like nails.
3. Identifying a buried metal object before you dig it up.
4. Estimating the size and depth of objects, to facilitate digging them up.
5. Eliminating the effects of electromagnetic interference from other electronic devices.

Your metal detector is designed with these things in mind:

### 1. Ground Minerals

All soils contain minerals. Signals from ground minerals can interfere with the signals from metal objects you want to find. All soils differ, and can differ greatly in the type and amount of ground minerals present. This detector has proprietary circuitry to automatically eliminate interfering signals from minerals that occur naturally in the ground.

*NOTE: This detector will not completely eliminate interference from all types of minerals. For example, the detector IS NOT designed for use on wet sand saltwater beaches. Another example of soil this detector will not eliminate is any soil containing large concentrations of iron oxides, which are usually red in color.*

### 2. Trash

If searching for coins, you want to ignore items such as aluminum foil and nails. You can see the Target-ID of the buried objects, listen to the sounds and then decide what you want to dig up. Or, you can eliminate unwanted metals from detection by using the NOTCH feature.

### 3. Identifying Buried Objects

Metal objects are identified along the 9-segment Conductivity graphic symbols. This scale is an indicator of the relative electrical conductivity of different objects. Segments to the right indicate more conductive targets. Iron objects, which are usually of lesser value, illuminate on the left with the Fe symbol. Silver objects will be illuminated on the rightmost segments.

### 4. Depth of Buried Objects

The 6-segment graphic indicates the relative depth of a buried metal object. For a given object, the more distance between it and the searchcoil, the more segment lines illuminated.

# THE BASICS OF METAL DETECTING

## 5. EMI (Electromagnetic Interference)

The searchcoil produces a magnetic field and then detects changes in that magnetic field caused by the presence of metal objects. This magnetic field the detector creates is also susceptible to the electromagnetic energy produced by other electronic devices. Electric fences, cell phones, cell phone towers, power lines, microwave ovens, lighting fixtures, TVs, computers, motors, etc... all produce EMI which can interfere with the detector and cause it to beep when no metal is present, and sometimes to beep erratically.

The SENSITIVITY control lets you reduce the strength of this magnetic field and therefore lessen its susceptibility to EMI. You may want to operate at maximum strength, but the presence of EMI may make this impossible. If you experience erratic behavior or "false" signals, **reduce the sensitivity.**

## USING THE DETECTOR

### Sweep Method

Sweep the detector side-to-side over the ground.

Keep the searchcoil parallel to the ground as you sweep; do not lift the searchcoil at the ends of your sweeps.

Searchcoil motion is required for target detection.

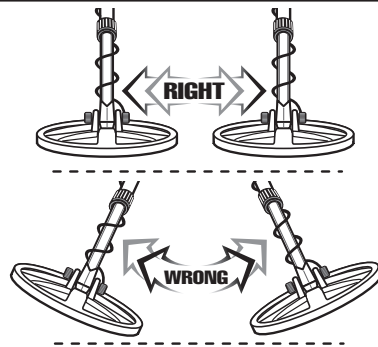

## WATERPROOF SEARCHCOIL

This detector is equipped with a 7" diameter round elliptical waterproof searchcoil. This lightweight, ruggedly constructed searchcoil can be fully submerged in water. The bottom portion of the pole assembly can also be submerged, but the control housing and the searchcoil cable plug connection into the housing must be kept dry.

Accessory searchcoils are also available for purchase; see back cover or visit [www.fisherlab.com](http://www.fisherlab.com). A smaller searchcoil offers more precision and fits into tight spaces. Larger searchcoils provide for more ground coverage on each sweep and penetrate deeper into the ground.

# OPERATION and CONTROLS

## POWERING UP

At power-up the Menu default is Volume and the Mode default is Jewelry.

## HOW TO WORK THE CONTROLS

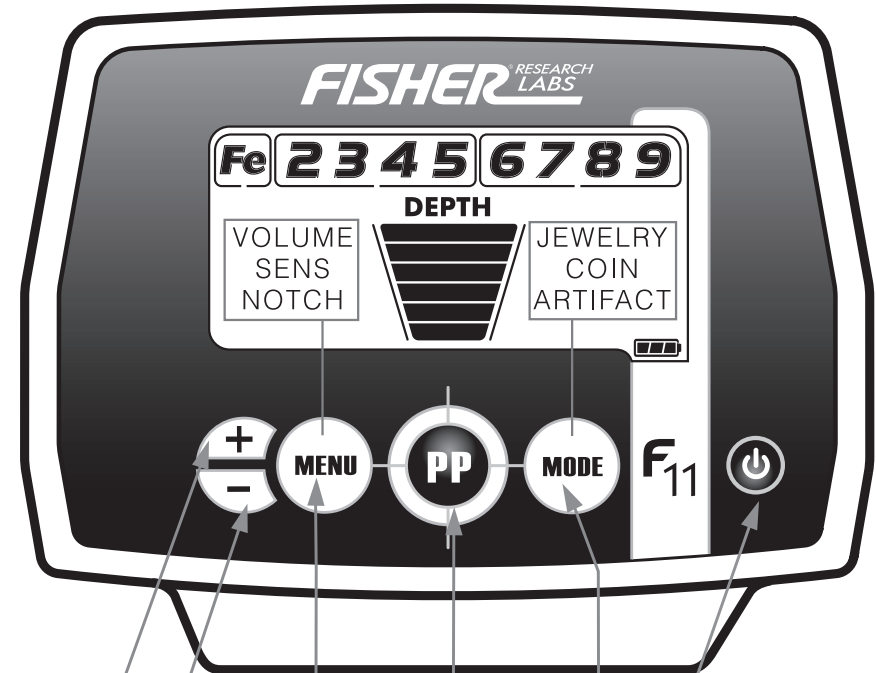

Press **+** or **-** to INCREASE or DECREASE menu settings.

Press and hold **PP** to enter Pinpoint.

**POWER ON/OFF**

Press **MENU** to cycle through menu items: **VOLUME, SENSITIVITY** or **NOTCH.**

Press **MODE** repeatedly to cycle through search modes **JEWELRY, COIN** or **ARTIFACT.**